

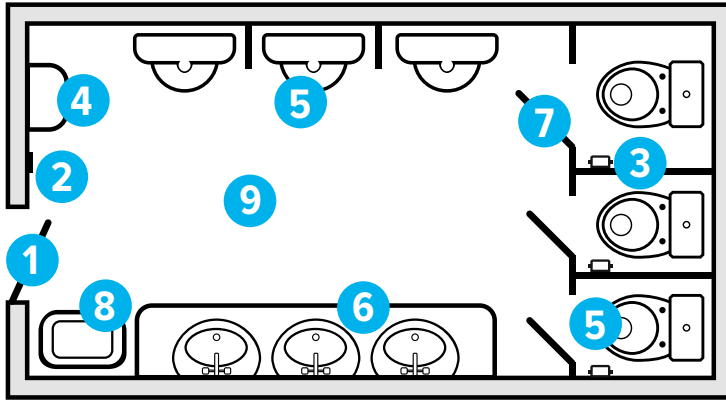









RESTROOM

Countless students, staff members, and visitors use shared school restrooms every day. Keep *Everything Clean* by properly cleaning and disinfecting these commonly-touched surfaces.



Key Touchpoints for cleaning include:

- 1  Door handles
- 2  Light switches
- 3  Dispensers (soap, toilet paper, etc.)
- 4  Paper towel holders
- 5  Toilet/urinals (handle, seat, etc.)
- 6  Faucets and sinks
- 7  Stalls and stall handles
- 8  Trash/recycling receptacle
- 9  Floors/walls